

Surface Track

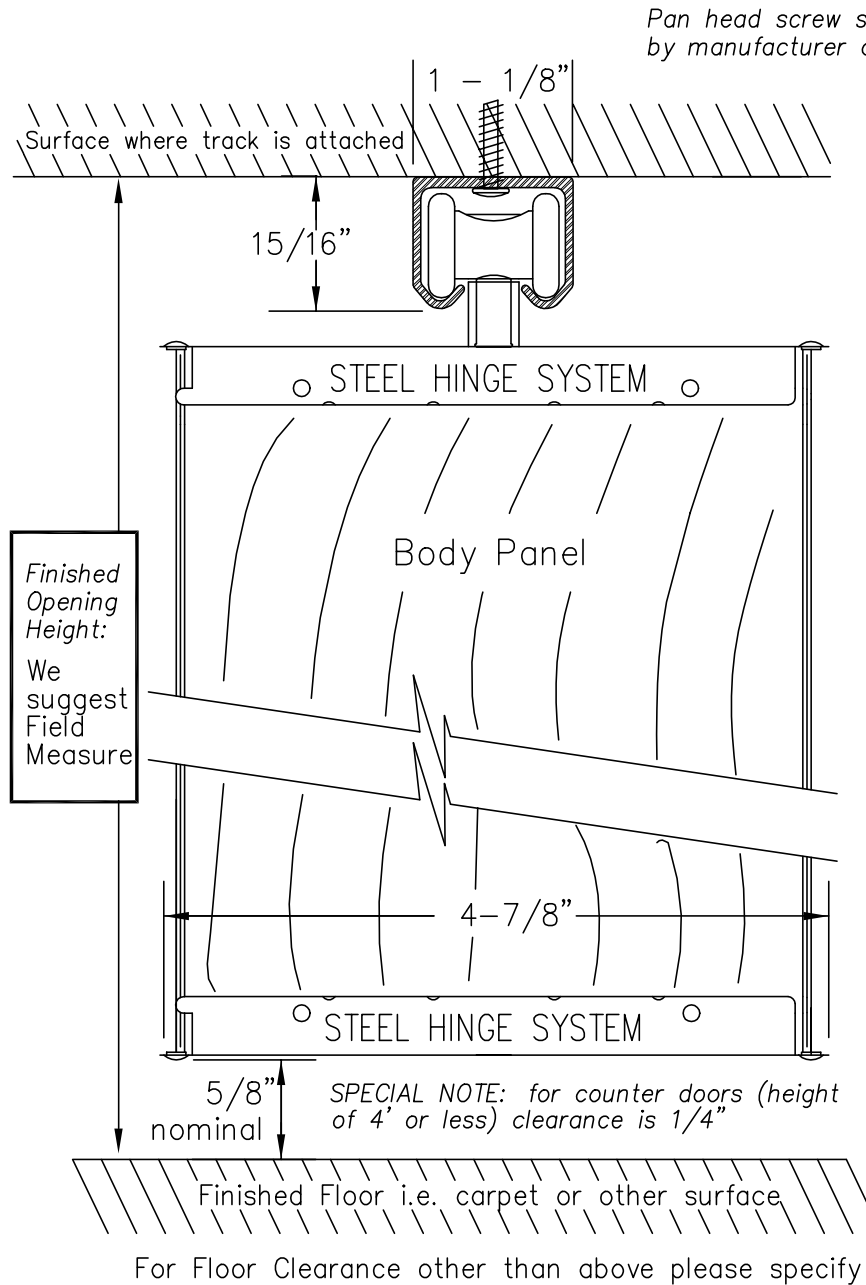

Pan head screw supplied by manufacturer or equivalent

CAD SRTK-240

○ SURFACE TRACK — MODEL 240